



# REGENERATIVE DRYING SYSTEMS

User Manual  
Installation Instructions

!! Please Retain This Manual for Your Records !!



a division of:  
Suburban Manufacturing, Inc.  
Monticello, MN 55362  
1-800-782-5752



Take your compressed air system into the future with the newest regenerative drying system.

Suburban Manufacturing, Inc. 10531 Dalton Ave NE Monticello, MN 55362 USA  
(800)782-5752 fax (763) 295-6601

Tsunami Compressed Air Solutions is a division of



# **YOUR SAFETY IS IMPORTANT**

Read ALL instructions before you begin the installation of your  
Tsunami Regenerative Drying System

Observe and follow all caution and warning instructions

## **!!CAUTION!!**

**\*\*SYSTEM PRESSURE MUST BE RELEASED  
PRIOR TO INSTALLING DRYER\*\***

- Tsunami Regenerative Drying Systems should be installed with a bypass circuit to allow for proper maintenance of unit
- Always wear eye protection when working on Tsunami Regenerative Drying Systems
- Use only proper tools and follow all precautions which pertain to the use of those tools
- Use appropriate thread sealant on all fittings unless otherwise specified

## **\*\*IMPORTANT\*\***

There is a MANDATORY 6 month maintenance schedule for the Oil coalescing pre-filter, P/N 21999-0202-Z-SP

There is a MANDATORY 1 year maintenance schedule for the lubrication of the piston spool and piston bore.

Failure to follow all maintenance schedules will void all warranties

**\*\*It is MANDATORY to install a bypass circuit around the dryer for maintenance purposes\*\***

NOTES

---

---

---

---

---

---

---

---

---

---

---

---

---

---

---

---

---

---

---

---

---

---

---

---

---

---

— use appropriate thread sealant on all fittings unless otherwise specified —



## Tsunami Regenerative Dryer Warranty Registration Information

Dear Valued Customer,

Congratulations on the purchase of your new Tsunami Regenerative Drying System.

Our goal is to exceed your expectations by providing you with all of the necessary information for maintaining your product in optimum working condition. If you have any questions or concerns please contact us at [1.800.782.5752](tel:18007825752) or [info@gosuburban.com](mailto:info@gosuburban.com)

How to register your dryer:

- 1) Look for serial number on dryer PLC (silver tag)
- 2) Register your dryer online at [www.gosuburban.com](http://www.gosuburban.com) under Warranty Registration
- 3) Fill out all registration info to receive your 3 year warranty
- 4) For more details on warranty coverage please see Limited Warranty page provided with your dryer.

For your records:

Model: \_\_\_\_\_ Serial No. \_\_\_\_\_

Purchase Date: \_\_\_\_\_

Purchase From: \_\_\_\_\_

Phone: \_\_\_\_\_ Email: \_\_\_\_\_

Sincerely,

Suburban Manufacturing, Inc.

# TABLE OF CONTENTS

Safety Precautions	Page	2
Table of Contents	Page	3
Technical Description	Page	4
Installation Guidelines	Page	5
Wall Mount Installation	Pages	6-8
Ultra System Installation	Page	9
Stand Alone Dryer Installation	Page	10
Programmable Logic Controller	Page	10
Maintenance Guide	Pages	11-13
Warranty Registration	Page	14

Congratulations on your purchase of the Tsunami Regenerative Drying System. We are very pleased that you have decided to use the latest technology to improve your compressed air system.

Your air system, using regenerative drying technology, will provide years of service with little maintenance required.

Thank You.

# The Tsunami Regenerative Dryer



## Product Description

The Tsunami Regenerative Dryer System uses the latest technology to provide your facility with the cleanest, driest compressed air available. Our systems, unlike some of our competitors, are complete systems. This includes the Tsunami water separators and Tsunami oil coalescing filters. We use Moisture Minder® automatic piston drains to assure proper draining of water and oils before the dryer.

We can configure systems to provide very low dew points (down to -80° F) or very low relative humidity (down to .01%) with very low sweep rates. Flow rate and sweep rate determine the quality of your compressed air.



- This technology functions by passing wet, dirty compressed air through the Tsunami water separator which removes bulk water and oil down to 10 microns, then the air passes through the Tsunami oil coalescing filter which further removes oil and particulates down to .01 micron.
- This pretreated air enters the dryer and passes through one or more desiccant canisters.
- These canisters are filled with a molecular sieve bed which is under tight compression, so there is virtually no movement or banging together of the beads to cause material break down. Our desiccant media is also encapsulated in a 10 micron filter bag which eliminates the possibility of desiccant carryover downstream.
- As the wet air passes through the towers, the molecular sieve draws the water vapor in while under pressure. At the same time, one or more towers are depressurized. These towers discharge water vapor through the mufflers below those towers with the use of sweep air.
- The PLC controller sends out a pilot signal for an internal spool to shift, which switches the flow of air through the towers.
- This switching of tower operation now allows wet, incoming air to flow through a new or previously dried tower. We take a little air from the dry, outlet flow and direct this air backward through the wet towers via a very small orifice in the regeneration valve. (This is referred to as sweep air or the regeneration process). This dry flow of air through the wet beads will dry them out so they are ready for a new cycle. It's like changing your desiccant every few minutes. Our system assures a continuous flow of clean, dry compressed air for your needs.

### The Drying Process

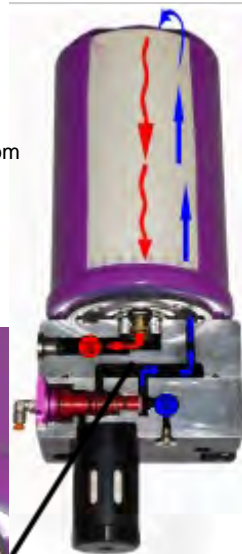
-  Wet Incoming Air  
— supply air from compressor or from the compressor system
-  Dry Outgoing Air  
— air that has had the water vapor removed



### The Regeneration Process

-  Dry Outgoing Air  
— small amount of dry air used to "sweep" or regenerate the towers
-  Wet Discharge Air  
— water vapor which was removed during the drying cycle

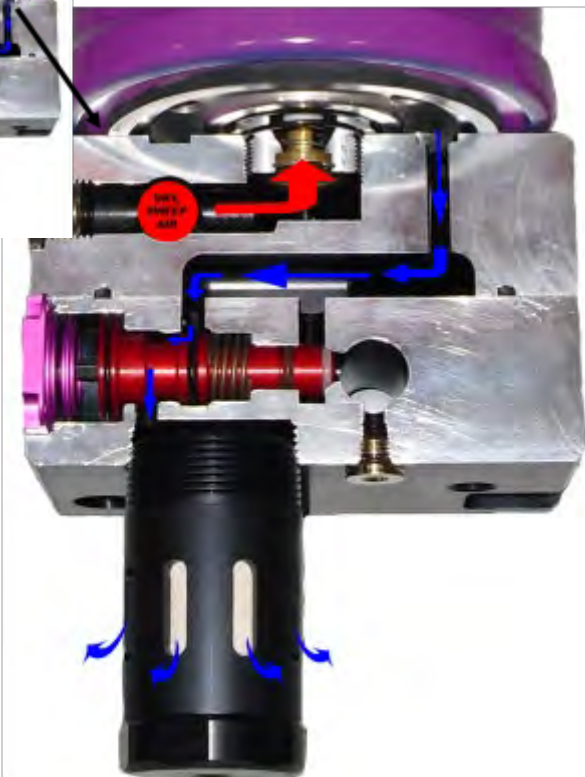
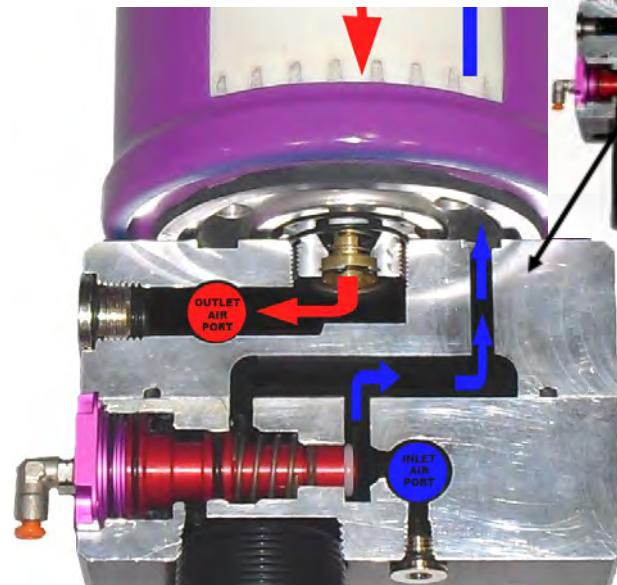
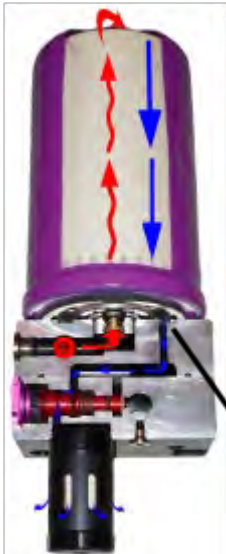

## Trouble Shooting Guide Tsunami Regenerative Dryer

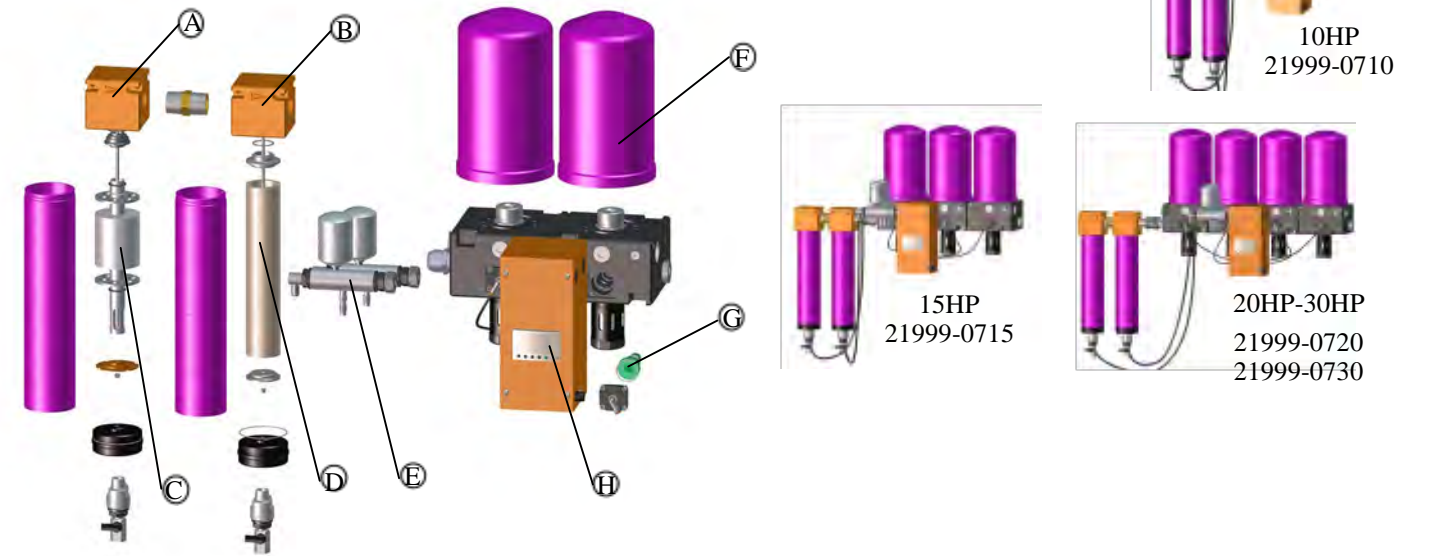

A	Water Separator	
B	Coalescing Filter	
C	Water Separator Kit	21999-0228
D	Coalescing Filter Kit	21999-0202-Z-SP

E	Moisture Minder Drain	152-0000-R
F	Desiccant Tower	21999-0349
G	Piston Rebuild Kit	21999-0707
H	PLC-PLC Display	

Problem	Possible Cause	Corrective Action
Water/Oil Carry Over	1-Water Separator not getting drained 2-Moisture Minder stuck or not working properly 3-Coalescing filter element saturated or cracked 4-Desiccant Tower saturated or oil has gotten on the desiccant 5-Over flowing dryer 6-Dryer not sized properly	1-Drain manually and see if Moisture Minder is cycling. 2-See if Moisture Minder is dispersing water, if not replace 3-Replace coalescing filter element 4-Replace desiccant tower 5-Reduce the CFM being consumed downstream of dryer, contact distributor 6-Contact your distributor for more info
Excess Air blowing out of muffler	1-Piston stuck	1-Grease or replace piston
On 15-30HP dryers only cycling between tower one and tower two	1-PLC program has been changed	1-Contact your distributor for more info
Dryer not cycling	1-Power cord damaged 2-PLC in stop mode	1-Replace power cord 2-Contact your distributor for more info

# INSTALLATION INSTRUCTIONS

**\*\*SYSTEM PRESSURE MUST BE RELEASED PRIOR TO INSTALLING DRYER\*\***

## Piston and Bore Lubrication

Depressurize the unit prior to any element change or service.

Each piston and piston bore follow the same maintenance routine.

Note: Each canister contains one piston.

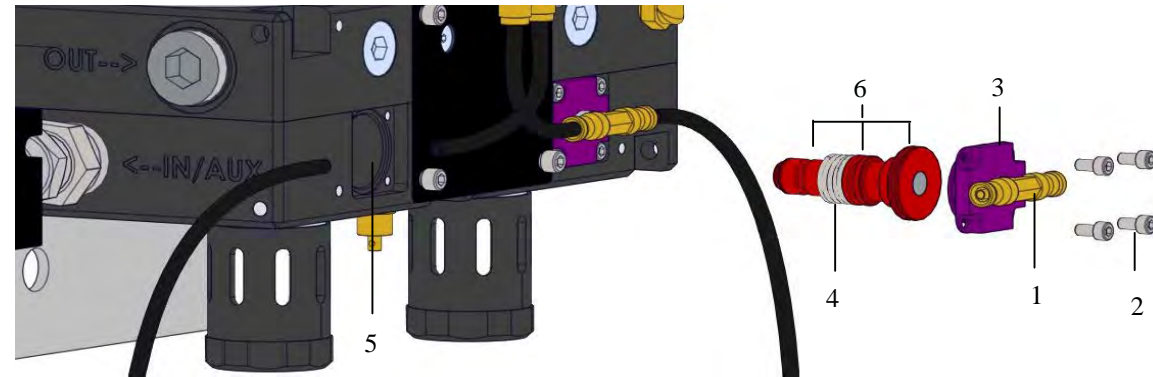

Ref No.	Description
1	Quick Connect Fitting
2	Socket Head Cap Screws
3	Piston Cover

Ref No.	Description
4	Piston Spring
5	Piston Bore
6	Piston O-Rings

- 1) Disconnect tubing from Quick-Connect Fitting located on the piston cover. Push in on orange ring. While holding ring in, pull out tubing.
- 2) Remove the four Socket Head Cap Screws holding the piston cover in place (4mm Hex Key Wrench).
- 3) Remove Piston Cover for access to piston.
- 4) Using a finger or a 1/2-13 bolt, remove the Piston from the Piston Bore; be sure you remove the Piston Spring.
- 5) Using the provided grease, lubricate the Piston Bore. Grease thoroughly.
- 6) Lubricate the three Piston O-rings shown above. Grease thoroughly.  
*Note: It is unnecessary to grease the bottom Piston O-ring (small diameter).*
- 7) Re-install the Piston and Piston Spring.
- 8) Reattach the Piston Cover using the four Piston Socket Head Screws.
- 9) Reconnect pilot line tubing to Quick Connect Fitting located on Piston Cover.

- This instruction manual contains the installation guide for all Tsunami Regenerative Drying Systems.
- All wall mounted dryers follow the same installation procedures
- The programming of the PLC controller is pre-set from the factory
- The PLC contains one notification alerting you to perform your 6 month maintenance on the oil coalescing pre-filter

## Features of the Tsunami Regenerative Dryers

Dual inlet ports and outlet ports provides for easier installation. The unique design of this modular system also allows compressed air to bypass through the inlet chamber for use downstream without having to pass through the drying technology.

Tower mounting stud with built-in regeneration valve. The size of the regeneration orifice controls how much air is used by the system to dry the towers. Reducing air volume and increasing orifice size can provide even lower dew points; down to -80°F.

Dryer housings are machined from solid aluminum blocks. Hard coat anodize provides superior strength and corrosion resistance.

Pre-filtration consists of a Tsunami water separator and oil coalescing filter. These units can handle up to a quart of liquid per minute for extremely wet and dirty air systems.

Moisture Minder pneumatic drains automatically actuate with the dryer to eliminate any water and oil trapped by the Tsunami pre-filters. Eliminates the need for float drains on our pre-filtration.

Single piston spool per tower reduces the number of moving components. Makes for easy maintenance.

PLC controller allows for more consistent air flow by staggering tower sequencing.

# Installation procedures for wall mounted Tsunami Regenerative Dryers

**\*\*It is MANDATORY to install a bypass circuit around the dryer\*\***

**!! IMPORTANT !!**

The inlet air temperature to all drying technology affects how dry your outlet air is.

Compressors without a radiator type after cooler should allow a minimum of 20 feet of distance between the compressor and the Tsunami Regenerative Dryer

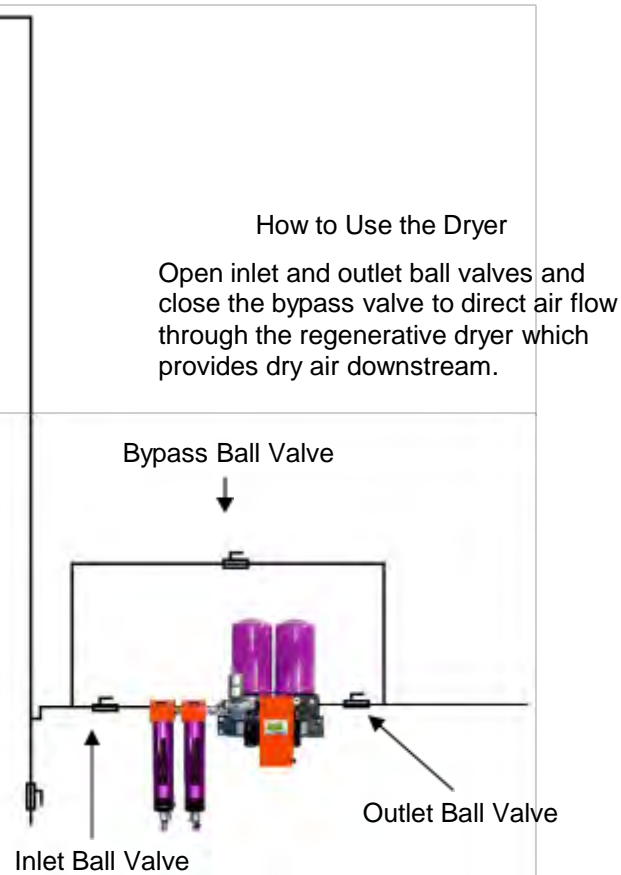
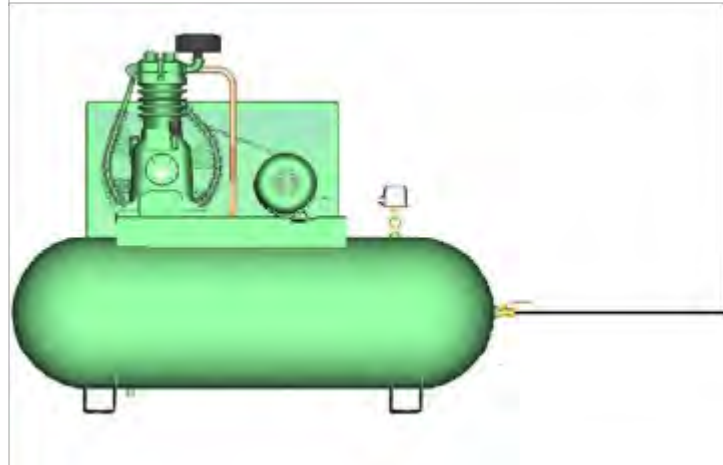

How to Use the Dryer

Open inlet and outlet ball valves and close the bypass valve to direct air flow through the regenerative dryer which provides dry air downstream.

Bypass Ball Valve

Inlet Ball Valve

Outlet Ball Valve

How to Bypass the Dryer

Close inlet and outlet ball valves and open the bypass valve to direct air flow around the dryer which allows you to perform maintenance or service

**NOTE:** For optimal system efficiency, close inlet and outlet ball valves when air system is idle

**9** At the end of the day and over the weekend or anytime compressed air is not being used ...

# Maintenance Schedule for All Tsunami Regenerative Dryer Systems

Every 6 months: **(Mandatory)**

Replace the oil coalescing element

Once per year : **(Mandatory)**

Lubricate the piston spool and piston bore using the grease provided in the replacement element kit.



P/N 21999-0202-Z-SP  
Oil Coalescing Replacement Element



P/N 21999-0707  
Piston Rebuild Kit



P/N 21999-0349  
Tower Replacement

**3-5 year Maintenance Program:**  
(Strongly Recommended)

Replace piston spool valve - one per tower  
P/N 21999-0707

Replace molecular sieve canisters (towers)  
P/N 21999-0349

Perform 6 month maintenance requirement  
P/N 21999-0202-Z-SP

**\*\*SYSTEM PRESSURE MUST BE RELEASED PRIOR TO PERFORMING MAINTENANCE PROCEDURES\*\***

## Replacing the oil coalescing pre-filter element

Step 1: Open ball valve on bottom filter housing to release any system pressure



Step 3: Remove the bottom nut and replace element



Step 2: Remove drain line and unscrew the filter housing



Step 4: Screw housing onto filter head and attach drain line. Be sure to close ball valve on the bottom of the filter



## Step 1:

Verify that you have received all dryer installation components supplied with your Tsunami Regenerative Dryer.



## All Dryer Systems include:

- Tsunami Regenerative Dryer
- Large Tsunami water separator and oil coalescing filter assembly for pre-filtering the air
- Wall mounting bracket
  - \* 10Hp Dryers use a single slot bracket
  - \*\* 15-30Hp Dryers use a dual slot bracket
- Fittings to connect pre-filters to dryer
- Port plugs
- Universal wall pack power supply - 100v to 240v
- Drain Tubing

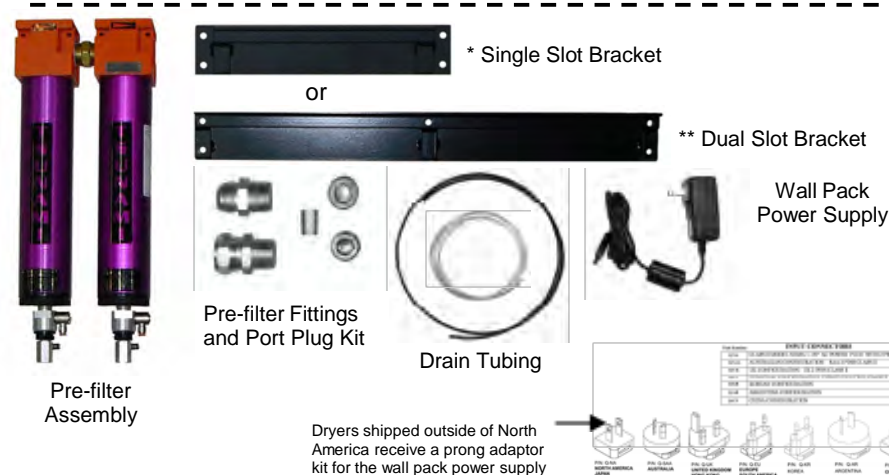

# Installation procedures for 50Hp Tsunami Stand Alone Drying System

**Step 1:**  
Connect inlet air supply to 1½" NPT port



**Step 2:**  
Connect outlet air supply to 1½" NPT port

**Step 2:**  
Mount dryer wall bracket to the wall using appropriate hardware.

- Single wall bracket must support 75 pounds
- Dual wall bracket must support 150 pounds



**Step 3:**  
Once the wall bracket has been properly secured to the wall, carefully place the dryer mounting rail into the slot(s) of the wall bracket.

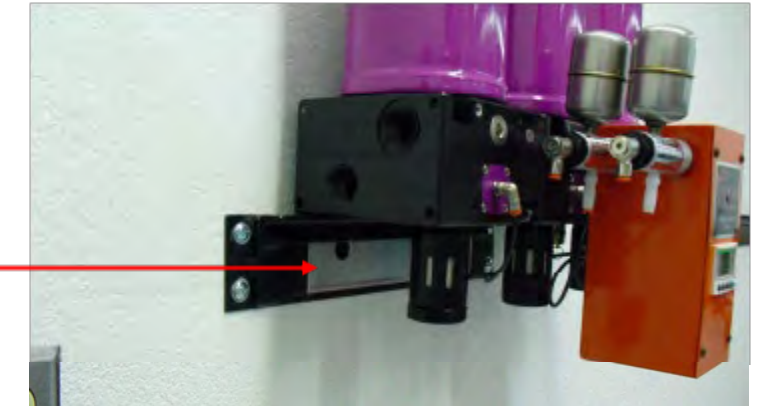

**Step 3:**  
Make sure the wall pack adaptor is connected to the PLC control box. Be sure to snug up the locking nut on the plug end. Plug wall pack into outlet.



International installations outside of North America must choose the correct prong adaptor for their region prior to plugging into power outlet. (see Page 8, Step 10b)

## Programmable Logic Controller

- The PLC used on the Tsunami Regenerative Dryer is pre-programmed and should automatically jump into the run mode once the unit is plugged in to your power supply.
- There are 3 basic display screens: Run Mode, Stop Mode, and Warning mode. The warning mode tells you that it is time to perform your mandatory maintenance on the oil coalescing pre-filter of the dryer

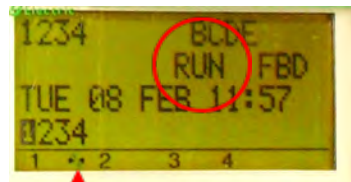

**RUN MODE**  
NORMAL OPERATING CONDITION

- RUN is displayed on the screen
- The little icons on the bottom of the display move in a rotating manner



**STOP MODE**  
PLC needs to be manually shifted to run mode (see below)

- STOP is displayed on the screen
- The little icons on the bottom of the display have stopped rotating



**WARNING MODE**

- Mandatory maintenance is due on the oil coalescing element
- To reset, press and hold in both the left and right arrow buttons for approx. 10 seconds

**Step 4:**  
Attach the female JIC connector to the outlet port of the Tsunami filter assembly. (as shown)  
**\*\*use appropriate thread sealant\*\***



**Step 5:**  
Install the male JIC connector to either the left or the right INLET / AUX port of the dryer.  
**\*\*use appropriate thread sealant\*\***



## How to get your PLC into the RUN Mode

**Step 1:**  
Press the Menu/OK button to bring up the menu screen.

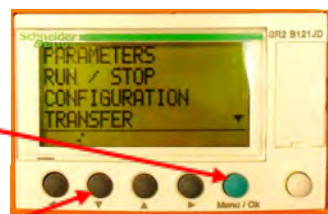

- Step 2:**
- Press the down arrow to highlight Run/Stop
  - Press the Menu/OK button to enter selection

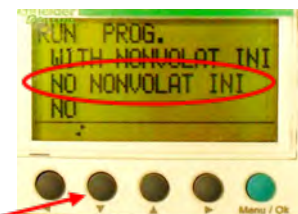

- Step 3:**
- Hit the down button until you highlight "NO NONVOLAT INI"
  - Press Menu/OK button to enter selection

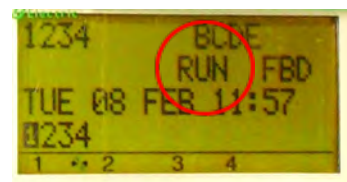

- Step 4:**
- PLC should now display the RUN MODE on screen

**Step 6:**  
Choose your outlet flow port, left or right.

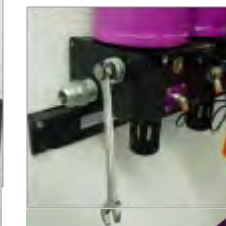

Plug the remaining open ports using the port plugs and port plug tool  
**\*\*use appropriate thread sealant\*\***



## Installation procedures for Tsunami Ultra Drying System



**Step 7:**  
Attach the filter assembly to the dryer by connecting the JIC fittings. Tighten firmly.

**Step 8:**  
Measure and cut the black tubing to connect the Moisture Minder® piston drains to the filter assembly. There is one drain per filter.  
It does not matter which drain goes to which filter.



**Step 9:**  
Measure and cut the clear plastic tubing to connect to the Moisture Minder® discharge ports. Route drain tubing to a bucket or a floor drain.

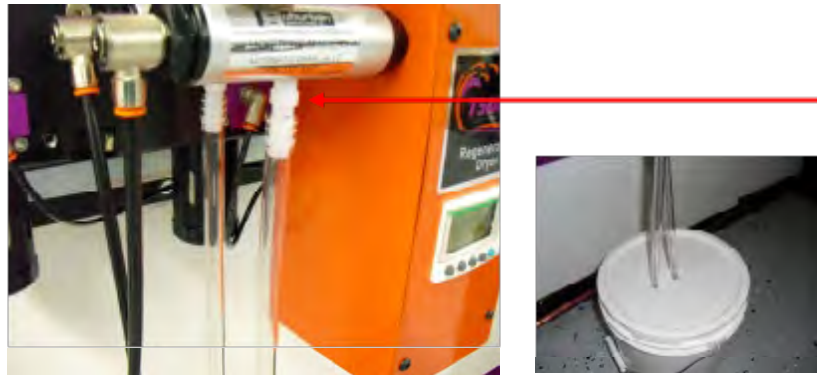

**Step 10a:**  
Connect the wall pack adaptor to the PLC control box. Make sure to snug up the locking nut on the plug end. Plug wall pack into outlet.



**Step 10b:**  
International installations outside of North America must choose the correct prong adaptor for their region prior to plugging into power outlet.

Part Number	INPUT CONNECTORS
Q-NA	CLASS II MODEL NEMA 1-15P AC POWER PLUG WITH 2 PRONGS
Q-SAA	AUSTRALIAN CONFIGURATION SAA 2 PINS CLASS II
Q-UK	UK CONFIGURATION UK 2 PINS CLASS II
Q-EU	EUROPEAN CONFIGURATION EUROPLUG 2 PINS CLASS II
Q-KR	KOREAN CONFIGURATION
Q-AR	ARGENTINA CONFIGURATION
Q-CN	CHINA CONFIGURATION

**Step 1:**  
Connect inlet air supply to 1" NPT port



**Step 2:**  
Connect outlet air supply to 1" NPT port on regulator

\*Optional check valve installation when installed at point of use. Drain tank prior to installation. Remove hose and elbow. Install check valve, elbow and hose.

**Step 3:**  
Make sure the wall pack adaptor is connected to the PLC control box. Be sure to snug up the locking nut on the plug end.  
Plug wall pack into outlet.

International installations outside of North America must choose the correct prong adaptor for their region prior to plugging into power outlet. (see Page 8, Step 10b)

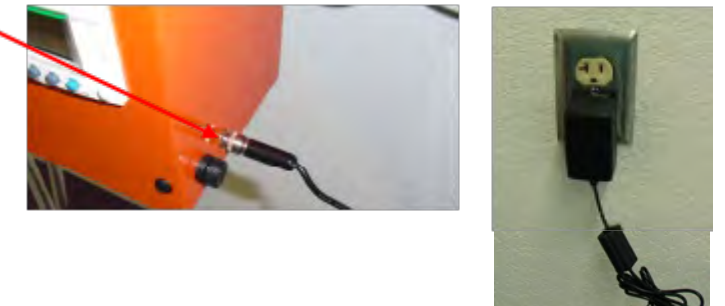

## How to Use the Bypass System on a Tsunami Ultra Drying System

**Drying Mode:**

3 way ball valve handle is up/down  
Outlet ball valve is horizontal



3 Way Ball Valve



Outlet Ball Valve

**Bypass Mode**

3 way ball valve handle is horizontal  
Outlet ball valve is up/down

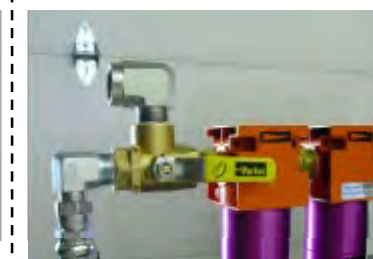

3 Way Ball Valve



Outlet Ball Valve

If your system has been in bypass mode for a while, open up the ball valve on the bottom of the tank and drain any moisture that may have been trapped while in the bypass mode.